



UNI12 BCD/U

SURFACE AND RECESSED PROFILE

PROFIL WPUSTOWO-NAWIERZCHNIOWY

- decorative and lighting profile
- 7 diffusers to choose from
- increased radiation – it is possible to use a stronger LED strip
- maximum LED strip width: 12 mm
- profil oświetleniowo-dekoracyjny
- 7 kloszy do wyboru
- zwiększona radiacja - możliwość zastosowania mocniejszej taśmy LED
- maksymalna szerokość taśmy LED: 12 mm



SIMILAR IN THE OFFER / PODOBNE W OFERCIE



DEEP10
BC/UX



GROOVE10
BC/UX



SURFACE10
BC/UX



BEGTON12
J/S



FLOOR12
K/U



GROOVE14
EF/TY



SURFACE14
EF/TY



UNI12 BCD/U

- B** slide cover
klosz B wsuwany
- C** click cover
klosz C klik
- C** lens cover
klosz C soczewka
- D** click cover
klosz D klik
- U**¹ flexible mounting plate
uchwyt U sprężysty
- U**² cone U flexible mounting plate
uchwyt U sprężysty cone

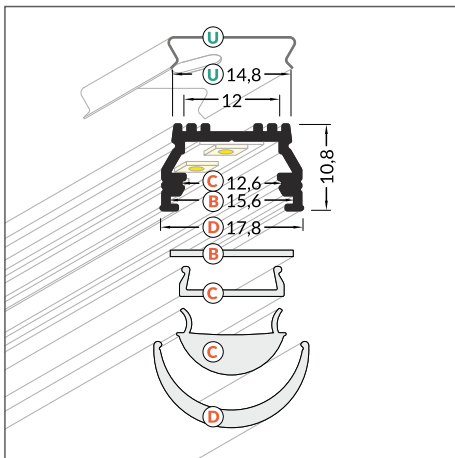
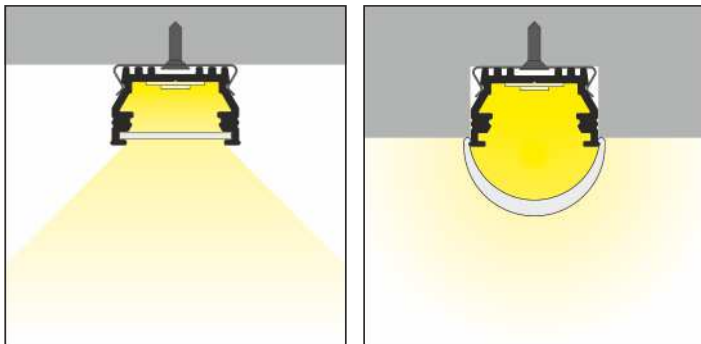
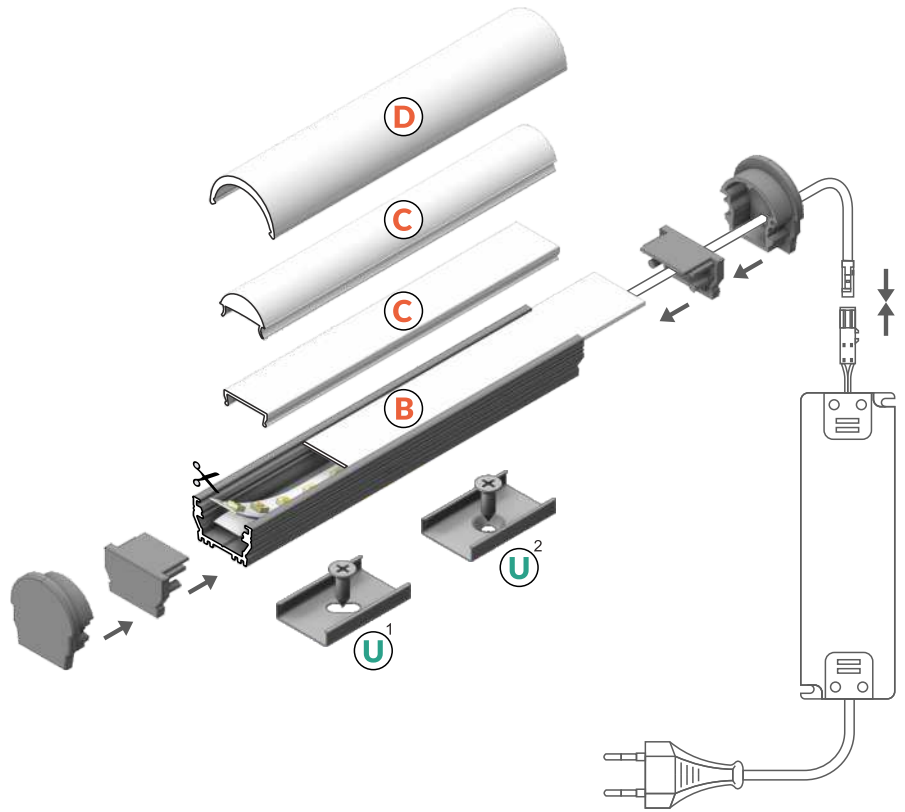

INDEX = 1 pc, length 2000 mm
package = 10 pcs
INDEKS = 1 szt., długość 2000 mm
opakowanie = 10 szt.

 white painted
biały malowany
A1020001

 anodized
anodowany
A1020020

 black anodized
czarny anodowany
A1020021

 raw aluminium
surowe aluminium
A1020000

 max 12 mm

 surface
nawierzchniowy

 recessed
wpustowy

Available lengths / Dostępne długości
1000 mm, 2000 mm, 3000 mm, 4000 mm



COVERS / KLOSZE

B slide cover

colours: transparent, frosted, white
material: PC, PP, PP

klosz B wsuwany
kolory: transparentny, szron, mleczny
materiał: PC, PP, PP



Note! Dimensions of the space to install LED source
Uwaga! Wymiary przestrzeni do zamontowania źródła LED

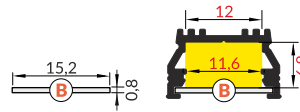

C click cover

colours: transparent, white
material: PMMA

klosz C klik
kolory: transparentny, mleczny
materiał: PMMA

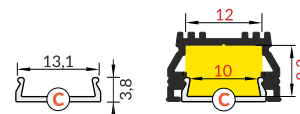

C lens click cover

colour: transparent
material: PC

klosz C klik soczewka
kolor: transparentny
materiał: PC

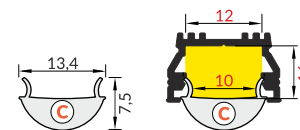

D click cover

colour: white
material: PMMA

klosz D klik
kolor: mleczny
materiał: PMMA

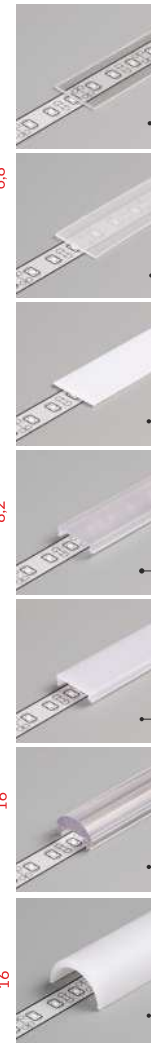
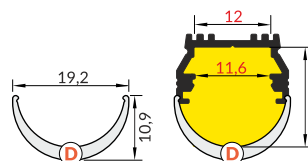

INDEX = 1 pc, length 2000 mm
package = 10 pcs
INDEKS = 1 szt., długość 2000 mm
opakowanie = 10 szt.

B transparent / B transparentny
76250016

B frosted / B szron
76250039

B white / B mleczny
76250038

C transparent / C transparentny
76330000

C white / C mleczny
76330038

C lens / C soczewka
76300000

D white / D mleczny
A1140038

MOUNTINGS / MOCOWANIA

U flexible mounting plate

colour: inox
material: stainless steel

uchwyt U sprężysty
kolor: inox
materiał: stal nierdzewna

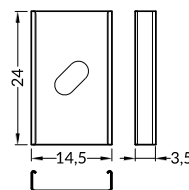
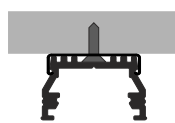

cone U flexible mounting plate

colour: inox
material: stainless steel

uchwyt U sprężysty cone
kolor: inox
materiał: stal nierdzewna

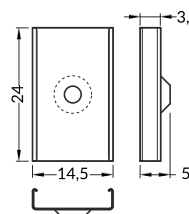
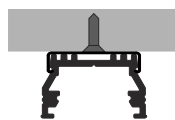

INDEX = 1 set
package of 10 sets = 20 pcs
INDEKS = 1 komplet
opakowanie zawiera 10 kpl = 20 szt

U flexible mounting plate
uchwyt U sprężysty

inox
inox 76380000

cone U flexible mounting plate
uchwyt U sprężysty cone

inox
inox 76620000

CONNECTORS / ŁĄCZNIKI

UNI12 connector 90 deg

colours: white, anodized, black
material: aluminium

łącznik UNI12 90 st
kolory: biały, anodowany, czarny
materiał: aluminium

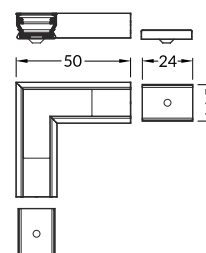

INDEX = 1 set
INDEKS = 1 komplet

white painted
biały malowany
A1910001

anodized
anodowany
A1910020

black anodized
czarny anodowany
A1910021



ENDINGS / ZAŚLEPKI

UNI12 ending

colours: white, silver, black, grey
material: ABS

zaślepka UNI12

kolory: biały, srebrny, czarny, szary
materiał: ABS

UNI12 ending with hole

colours: white, silver, black, grey
material: ABS

zaślepka UNI12 z otworem

kolory: szary, czarny, biały, srebrny
materiał: ABS

UNI12 D ending

colours: white, silver, black, grey
material: ABS

zaślepka UNI12 D

kolory: biały, srebrny, czarny, szary
materiał: ABS

UNI12 D ending with hole

colours: white, silver, black, grey
material: ABS

zaślepka UNI12 D z otworem

kolory: szary, czarny, biały, srebrny
materiał: ABS

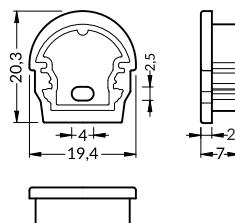
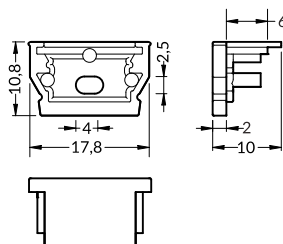

INDEX = 1 set
package of 10 sets = 20 pcs
INDEKS = 1 komplet, opakowanie
zawiera 10 kompletów = 20 szt.

	white / białe	
	with hole z otworem	without hole bez otworu
	A1090001	A1070001
	silver / srebrne	
	with hole z otworem	without hole bez otworu
	A1090040	A1070040
	black / czarne	
	with hole z otworem	without hole bez otworu
	A1090002	A1070002
	grey / szare	
	with hole z otworem	without hole bez otworu
	A1090022	A1070022

	white / białe	
	with hole z otworem	without hole bez otworu
	A1960001	A1940001
	silver / srebrne	
	with hole z otworem	without hole bez otworu
	A1960040	A1940040
	black / czarne	
	with hole z otworem	without hole bez otworu
	A1960002	A1940002
	grey / szare	
	with hole z otworem	without hole bez otworu
	A1960022	A1940022



PL

Made in Poland
Wyprodukowane w Polsce



EU-registered industrial design
Wzory przemysłowe EU

TOPMET LIGHT Kłósowicz Wiśniewski i Wspólnik Sp. j. ADDRESS: Ostrowska 354, 61-312 Poznań, POLAND
tel. +48 61 87 27 500, fax. +48 61 87 27 518 biuro@topmet.pl, www.topmet.pl

The catalogue is not an offer under Polish Civil Code regulations. Colours of particular products may vary slightly from colours shown in pictures. The dimensions given are approximate and can not be a reason for complaint. TOPMET Company reserves the right to make technical changes.
Folder nie stanowi oferty w myśl przepisów Kodeksu Cywilnego. Aktualną ofertę firmy stanowi cennik. Kolory poszczególnych produktów mogą się nieznacznie różnić od kolorów prezentowanych na zdjęciach. Podane wymiary są wymiarami orientacyjnymi i nie mogą stanowić podstawy reklamacji. Firma TOPMET zastrzega sobie prawo do wprowadzania zmian technicznych.

brochure designer • proj. folderu: M. Kędziora, A. Szafran 11.2016. photo • fot. K. Samulska, A. Szafran, L. Wesołowski