

PEN12 CJ

ROTATABLE DISPLAY LIGHTING SYSTEM

OBROTOWY SYSTEM OŚWIETLENIA EKSPOZYCYJNEGO

- wall and furniture application
- various types of mounting brackets
- maximum LED strip width: 12 mm

- ścienny i meblowy
- różne typy mocowań
- maksymalna szerokość taśmy LED: 12 mm



SIMILAR IN THE OFFER / PODOBNE W OFERCIE



PEN8
I



CABI12
E



CORNER10
BC/UX



TRIO10
BC



OVAL20
BC



- J** slide cover
klosz J wsuwany
- C** click cover
klosz C klik
- C** lens cover
klosz C soczewka

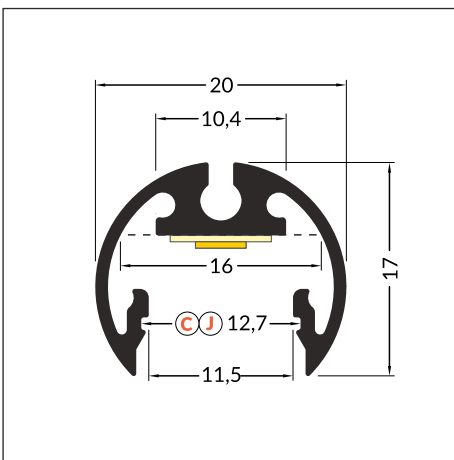
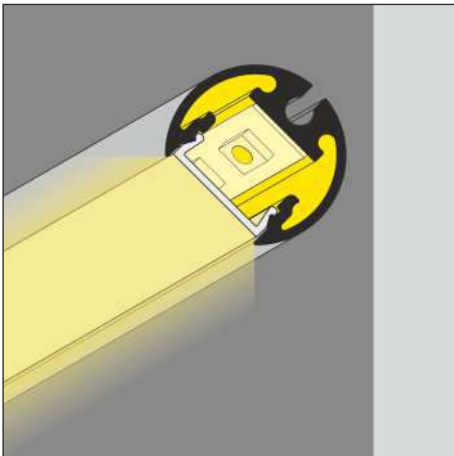
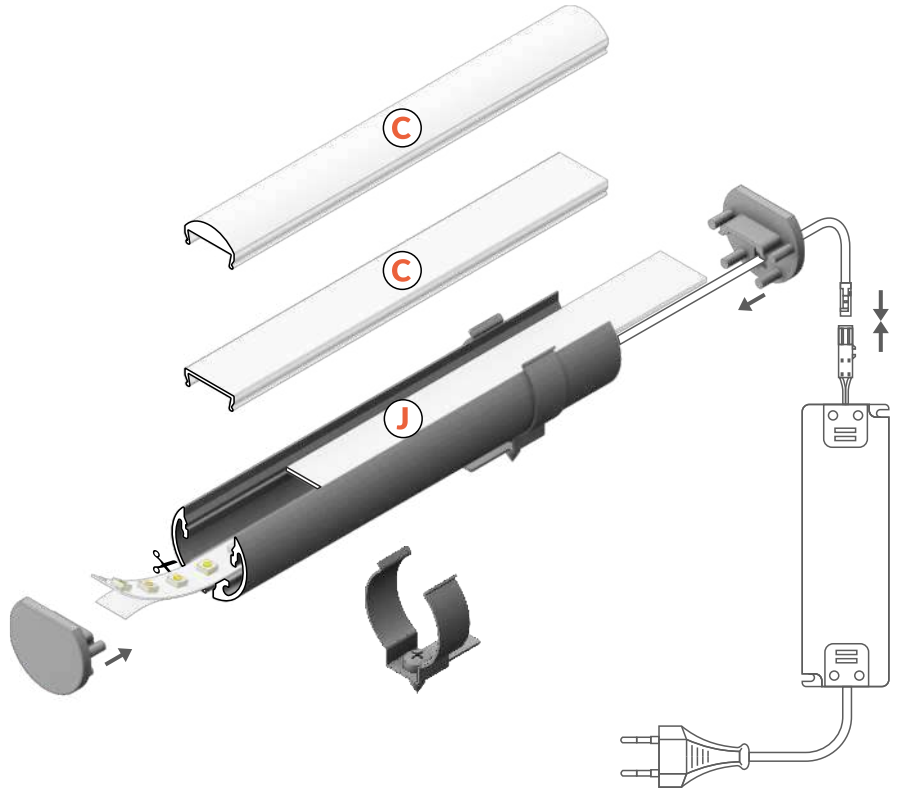

max 12 mm



special application
specjalny



INDEX = 1 pc, length 2000 mm
 package = 10 pcs
 INDEKS = 1 szt., długość 2000 mm
 opakowanie = 10 szt.

○ white painted
 biały malowany
 F7000201



● anodized
 anodowany
 F7000220



● black painted
 czarny malowany
 F7000202

Available lengths: 1000 mm, 2000 mm, 3000 mm, 4000 mm.
 The standard profile length tolerance is +20 mm.
 More details >> 1.08.

Dostępne długości: 1000 mm, 2000 mm, 3000 mm, 4000 mm.
 Standardowa tolerancja długości profili wynosi: +20 mm.
 Więcej informacji >> 1.08.



COVERS / KLOSZE

J slide cover

colours: transparent, frosted, opal
material: PC, PP, PP

klosz J wsuwany
kolory: transparentny, szron, mleczny
materiał: PC, PP, PP



Note! Dimensions of the space to install LED source
Uwaga! Wymiary przestrzeni do zamontowania źródła LED

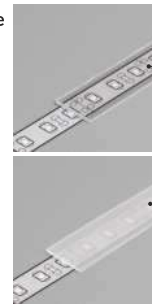
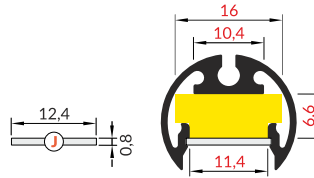

J transparent / J transparentny
70330016

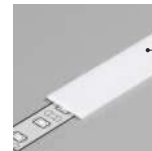

J frosted / J szron
70330039



J opal / J mleczny
70330038

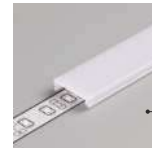

C transparent / C transparentny
76330000



C opal / C mleczny
76330038



C lens / C soczewka
76300000

C click cover

colours: transparent, opal
material: PMMA

klosz C klik
kolory: transparentny, mleczny
materiał: PMMA

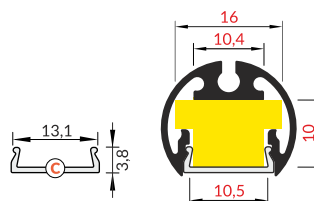

C lens click cover

colour: transparent
material: PC

klosz C klik soczewka
kolor: transparentny
materiał: PC

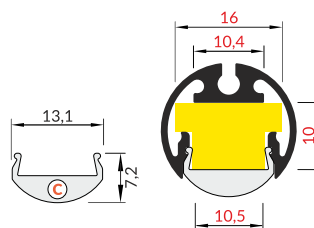

The standard cover length tolerance is +20 mm.
More details >> 1.08.

Standardowa tolerancja długości klosza wynosi: +20 mm
Więcej informacji >> 1.08.

ENDINGS / ZAŚLEPKI

PEN12 ending

colours: white, silver, black, grey
material: ABS

zaślepka PEN12
kolory: biały, srebrny, czarny, szary
materiał: ABS



Ending with marked space to bore the holes.
Zaślepka z punktami do przewiercenia otworów.

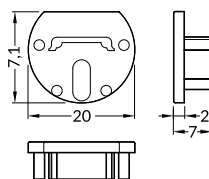

INDEX = 1 set
package = 10 sets = 20 pcs
INDEKS = 1 kpl
opakowanie = 10 kpl = 20 szt.

white
biały F7009901

silver
srebrny F7009940

black
czarny F7009902

grey
szary F7009922

MOUNTINGS / MOCOWANIA

PEN12 flat holder

colour: inox
material: stainless steel

uchwyt PEN12 płaski
kolor: inox
materiał: stal nierdzewna

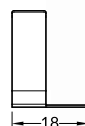
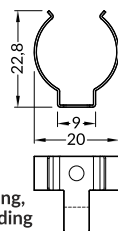

Horizontal mounting,
possible after bending
one of the handles.
Montaż poziomy
możliwy po docięciu
jednego z uchwytów.

INDEX = 1 set
package = 10 sets = 20 pcs
INDEKS = 1 kpl
opakowanie = 10 kpl = 20 szt.

inox
inox F7009019



MOUNTINGS / MOCOWANIA

PEN12 stretcher holder
colour: chrome
material: brass

uchwyt PEN12 rozporowy
kolor: chrom
materiał: mosiądz

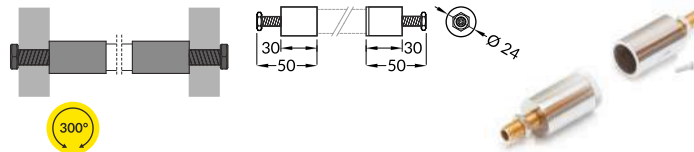

INDEX = 1 set = 2 pcs
INDEKS = 1 kpl = 2 szt.

chrome chrom F7009103

PEN12 ring holder
colours: chrome
material: brass

uchwyt PEN12 ring
kolory: chrome
materiał: mosiądz

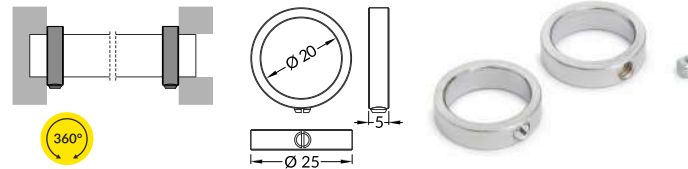

INDEX = 1 set = 2 pcs
INDEKS = 1 kpl = 2 szt.

chrome chrom F7009203

PEN12 double holder with thread
colour: chrome
material: steel, brass

uchwyt PEN12 podwójny z gwintem
kolor: chrom
materiał: stal, mosiądz

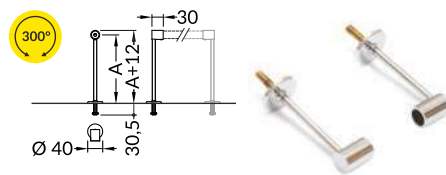

INDEX = 1 set = 2 pcs
INDEKS = 1 kpl = 2 szt.

A =
100 mm F7009303
200 mm F7009403
300 mm F7009503

PEN12 double holder with soffit ceiling
colour: chrome
material: steel, brass

uchwyt PEN12 podwójny z podsufitką
kolor: chrom
materiał: stal, mosiądz

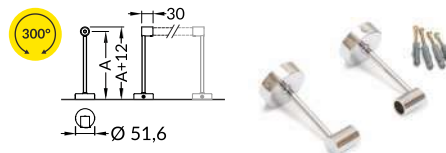

INDEX = 1 set = 2 pcs
INDEKS = 1 kpl = 2 szt.

A =
100 mm F7009603
200 mm F7009703
300 mm F7009803

PEN12 wall-mounted extension arm
colours: white, silver, black
material: steel, brass

uchwyt PEN12 wysięgnik ścienny
kolory: biały, srebrny, czarny
materiał: stal, mosiądz

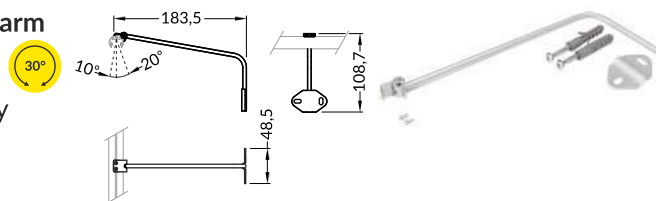

INDEX = 1 set = 1 pc
INDEKS = 1 kpl = 1 szt.

white biały F7008801
 silver srebrny F7008822
 black czarny F7008802

PEN12 cabinet-mounted extension arm
colours: white, silver, black
material: steel, brass

uchwyt PEN12 wysięgnik nadszafkowy
kolory: biały, srebrny, czarny
materiał: stal, mosiądz

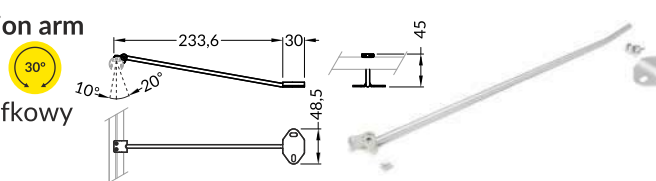

INDEX = 1 set = 1 pc
INDEKS = 1 kpl = 1 szt.

white biały F7008901
 silver srebrny F7008922
 black czarny F7008902

